

## MB454 SPF

User Manual

(3 device bay with 4 HDD slots)  
SATA Backplane Module



### <1>Packing content

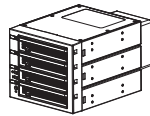

Product

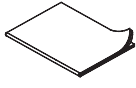

Manual

Accessory bag



Button head #6-32 12 pcs



Flat head #6-32 16 pcs

### <2>Front panel's light signal instruction

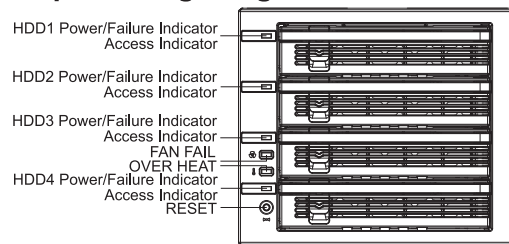

- 2.1. The Front panel's HDD signal lights are based on three colors in one.
- 2.1.1. When HDD is attached to the tray ; LED will show green light, which means power on.
  - 2.1.2. When HDD is running, LED will show orange light flashing, which means HDD is operating.
  - 2.1.3. When HDD fails, LED will show red light, which means HDD is faulty. (This signal should be provided by the HOST see 2.3)

#### 2.2. HDD FAIL system

- 2.2.1. This product can not provide the signal, unless the HOST supports this function.
- 2.2.2. If the Host can provide HDD fail signal, connect the cable to the HOST and to the backplane HDD FAIL 1 ~ 2 ~ 3 ~ 4.
- 2.2.3. When the HDD is damaged, the light will show red color.

#### 2.3. Cooling Fan damaged and product overheat warning:

Cooling Fan's characteristic: this product is designed to be replaceable ; it does not need to turn off power to replace a new one or remove it.

- 2.3.1. When Cooling fan stops running or fail, the Fan Fail light will show red, the alarm start to buzzer ; therefore push the reset button the buzzer will stop ; but the light will keep in red until the Fan is removed or replaced.
- 2.3.2. If Cooling Fan is not installed, the fan failure alarm will not transmit any signal.

Temperature control instructions: this product can be set at 45°C ~ 55°C ~ 65°C .

- 2.3.3. When the product temperature exceeds the temperature set, the light will appear in red, and the buzzer will start, and then press RESET to stop the buzzer. OVERHEAT light will keep in red, until the temperature is below the temperature setting.

### <3>Back plane description (labeled on the top side of the product)

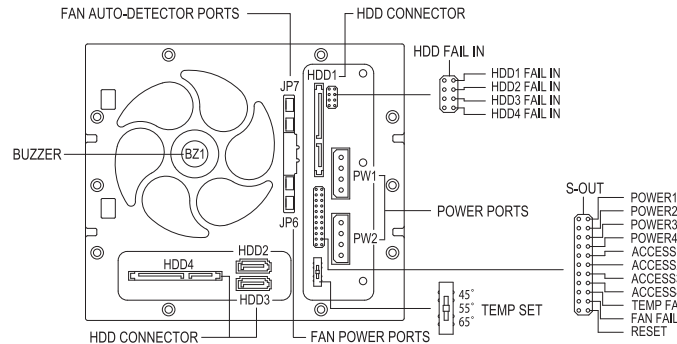

### <4>Instructions

A. Slide the button, handle will semi-reject, then remove the tray.

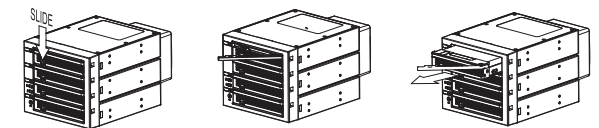

B. Remove the support rail and secure HDD to the removable tray, and then put it back into the main case.

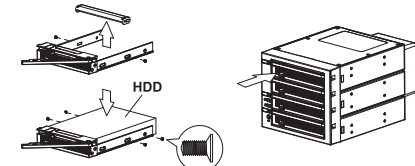

C. The Cooling Fan is removable when it is not needed. After removing Cooling Fan, the FAN FAIL system and alarm will not transmit any signal.

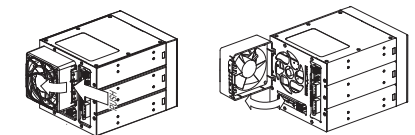

★Power supply : 2 x 4 PIN and 1 x15 PIN.

#### Note:

1. HDD failure will indicate red only when signals are transmitted by host. (Please refer to HDD-fail signal)
2. The above testing conditions were obtained at the surrounding temp at 25°C .
3. Any unrelated changes in the technical specification are subject to change without prior notice.
4. We will not be liable responsible for any software, hardware or other data stored within, or interfacing with our product which resulted to being damaged / dysfunctional. Cremax will only be responsible to repair / service its own product.
5. SATA II HDD specification has HDD ACCESS signal, but SATA I HDD does not have it.
6. SATA I it itself does not provide HDD Access signal; if required, please connect HDD Access cable, to ACC IN Access 1 ~ 2 ~ 3 ~ 4, then connect to the HOST Access signal to transmit the light to the panel.
7. SATA II HDD signal function design depends on the brand name / types used.
8. For any further inquiries about product application or more related product information, please linked to [www.icydock.com](http://www.icydock.com).